

TEAC TAPE RECORDER
SERIES R-110
INSTRUCTION BOOK

TOKYO DENKI ONKYO CO., LTD.
(TOKYO ELECTRO ACOUSTICAL CO., LTD.)
TEL. 631 - 1919. 3766. 3796. 7358
2-16 CHITOSE-CHO. SUMIDA. TOKYO

GENERAL

The TEAC R-110 Series tape recorder is a professional type tape recorder designed to perform high fidelity recording and reproducing of audio frequencies, and is composed of a tape deck of the 3 motor-4 head type, and a pre-amplifier having record and playback circuits. This tape recorder is capable of being installed either in a portable case, desk type cabinet, console cabinet, rack, etc. for use.

FEATURES

- 1) This 2 channel-4 head system tape recorder is capable of recording and reproducing various stereo and monaural programs.
- 2) Dual tape speeds of 7-1/2 ips and 3-3/4 ips are available through the exchange of capstans.
- 3) A hysteresis synchronous motor is used to drive the capstan.
- 4) Less tape speed deviation, wow and flutter.
- 5) A push button switch is used for the purpose of starting and stopping the tape.
- 6) A safety switch is utilized to automatically cut off the power to the deck in the event that the tape is broken or loosened during operation or the tape is completely taken up by the take-up reel.
- 7) An extremely short period of time is required for fast forward and rewind of the tape, and during this period the tape is automatically lifted from the surface of the heads by the tape lifter.
- 8) Each one of the heads is shielded fully and completely, and has excellent S/N.
- 9) Excellent frequency characteristics and distortion factor.
- 10) The machine is furnished with a footage counter.
- 11) An indication of the record or playback level is shown by the VU meter.

- 12) In the course of recording, monitoring from the tape can be accomplished.
- 13) The deck panel is made of an aluminum plate (5 mm in thickness) and is covered with stainless steel.
- 14) The current tape recorder is sturdy in its construction.

S P E C I F I C A T I O N S

Tape Width : 1/4 inch

Reel Size : 7 in. and 5 in.

Tape Speed : 7-1/2 ips, 3-3/4 ips.
Speed accuracy; within $\pm 0.5\%$
Deviation; within 0.5%

Recording Tracks : 2 channel, 2 track, stereo and double track
monaural, or 2 channel, 4 track, stereo and
4 track monaural.

Playback : 2 channel 2 track stereo and double track monau-
ral, 2 channel 4 track stereo and 4 track
monaural.

Frequency Response : 7-1/2 ips; 40 -15,000 cycles ± 3 dB or less
3-3/4 ips; 50 - 7,500 cycles ± 3 dB or less
(Record and playback curves are in conformity
with the NARTB standard)

SN Ratio : 2 track stereo or monaural; 50 dB or better
4 track stereo or monaural; 45 dB or better

Harmonic Distortion: Measured by proposed NARTB standard (400 cps. at
3% THD). Less than 2% at 1,000 cycles, 0 VU,
recording and playback.

Wow and Flutter : 7-1/2 ips.; less than 0.25% RMS
3-3/4 ips.; less than 0.3% RMS

Fast Forward
and Rewind Time : Approx. 45 seconds for 1,200 feet of tape.

Tape Starting and
Stopping Time :: Less than 0.5 seconds.

DATE RECEIVED
DATE COMPLETED
SERVICE

- Head : 4 heads; 2 track erase, record, playback, an 4 track playback, or 4 track erase, record, play ack, and 2 track playback.
- Monitor : During recording, simultaneous monitoring is possible either at the source (record input), or the tape (reproduce output).
- Input : Microphone; 50Ω, 150Ω, 250Ω, 600Ω, (exchange of plug-in transformer) high-impedance microphone (insertion of a shorted plug).
Line: 100 KΩ unbalanced -20 dB
- * A plug-in transformer for line input, when plugged in the microphone input, workes as a line input, making the mixing of 2 channel of line level possible.
- Output : Cathode follower output; Approx. 1.0 V.
- Dimensions : Refer to the diagram attached.
- Weight : Deck: Approx. 29 lbs.
Amplifier (per channel): 5.5 lbs.
- Power Requirements: 50 - 60 cycle, 100 - 115 V.
Power Consumption; Deck..... Approx. 100 VA
Amplifier (per channel)...
Approx. 50 VA

Component List :

Model	Deck Model	Amp. Model	Head Composition				Application
			1	2	3	4	
			Erase	Rec.	Play.	Play.	
R-111	TD-105A	AR-9C	Full track	Full track	Full track	-	Full track monaural
R-112	TD-105B	AR-9C	Half track	Half track	Half track	-	Half track monaural
R-113	TD-105C	AR-9C AR-9D	2 track	2 track	2 track	4 track	2 track stereo or monaural record, playback and 4 track playback
R-114	TD-105D	AR-9C AR-9D	4 track	4 track	4 track	2 track	4 track stereo or monaural record, playback and 2 track playback

(Notice) The following letters are attached to the end of the type number according to the kind of machined mounting.

Console cabinet C, Rack R,
Portable case P, No mount N.

Tape Deck	:	TD-105A	Deck used for R-111
		TD-105B	Deck used for R-112
		TD-105C	Deck used for R-113
		TD-105D	Deck used for R-114
		TD-105E	For 2 or 4 track playback only.
Amplifier	:	AR-9C	For the 1st stereo channel or monaural
		AR-9D	For the 2nd stereo channel

M O U N T I N G

R-110 ~ N type Reference is made to the dimensions required for mounting as illustrated in the accompanying drawing 1.

R-110 ~ P type Equipment of this type is dispatched from the factory in a portable case. It does not matter whether it is used in horizontal or a vertical position, but it should preferably be used in a vertical position from the view point of ventilation.

R-110 ~ C type The tape deck and the amplifier, after being out of their crates, are fixed into a cabinet with the attached screws.

R-110 ~ R type The tape deck and the amplifier, after being taken out of their crates, are fixed into a cabinet with the attached screws.

I N T E R - C O N N E C T I O N

The connections between the tape deck and the amplifier and between amplifiers are made as shown in drawing 3.

EXTERNAL - CONNECTIONS

- Microphone : The jacks available in the front and back of the panel are connected in parallel. Either of them may be used. Generally, a microphone of high impedance type is recommended. When a low impedance microphone is used, a suitable input transformer is recommended in place of the shorted plug. Input transformers for 50 Ω , 150 Ω , 250 Ω , and 600 Ω , are available, and all may be used balanced.
- Line Input : The "Line" terminal is used when recording from a disc, tuner, or another tape recorder. The "Line" terminal on the front panel and the "Line-In" terminal on the back panel are connected in parallel and either may be used. The output from the "Record-Out" terminal in your Hi-Fi preamplifier may be connected to the "Line" terminal.
- Output : Output is taken either from the pin-jack in the back of the amplifier or from "Output" on the front panel. These terminals are connected in parallel. The output, which is a cathode follower, can be directly connected to a power amplifier with a high impedance input, or the "Tape" or "Aux" terminals of a Hi-Fi preamplifier. When a 600 Ω balanced output is desired, the rear sub-panel (normally equipped with pin-jacks) needs to be changed with one designed for low impedance in which an output of 10 K : 600 Ω is furnished. In this case, the rear panel is equipped with 3 pin shielded connectors.
- Monitor : Monitoring is performed by plugging a head phone of high impedance type should be used. The supervising of level by the VU meter is also possible.
- Power Source: The AC cord in the back of the amplifier (1st channel) is connected to an AC power socket. The amplifier for the 2nd channel is supplied with AC power by a connecting cord from the amplifier for the 1st channel through the deck.

* When required to operate on a different power line voltage or frequency, refer to the article on "Power Voltage Alteration", page 14.

Make sure that the power switch is turned off before connecting the AC power cable to the power socket.

O P E R A T I O N

Controls and Indicators:

Deck

- Record Selector : Mono (channel 1 or 2), and Stereo recording.
- Recording Pilot : Indicates activation of the record and erase circuits.
- Record Button : Activates erase and record circuits.
(Notice) During playback, do not push the record button as this will erase sounds recorded on the tape.
- Start Button : Starts mode of operation indicated by the Function Switch.
- Stop Button : The deck circuit is disconnected by this button and activates brakes to stop the tape movement.
- Function Selector: This switch selects "Play", "Rewind", or "Fast Wind" modes of operation.
- Playback Selector: Changes the playback head for 2 or 4 track.
- Power : Connection of A.C. power to the deck.

Amplifier

- Record-Mic. : Control of microphone input level.
-Line : Control of line input level.
- Output-Source : Feeds program source to the output connectors.
-Tape : Feeds recorded program to the output connector
- Meter-Record : The meter indicates the input to the record amplifier.
-Output : The meter indicates the output from the playback amplifier.
- Equalization : Changes record and playback equalization for either FAST (7-1/2 ips) or SLOW (3-3/4 ips).

- Power-Channel 1: Controls power to both amplifiers and deck.
-Channel 2: Controls power to 2nd channel amplifier only.

Tape Speed

Speed is changed by installation or removal of a capstan sleeve and exchange of the pinch roller.

(Notice): At the time of shipment from the factory, the tape speed is set at 7-1/2 ips.

For operation at 3-3/4 ips:

1. Remove the capstan screw (see Fig. 1) by turning clockwise and remove the capstan sleeve.

(Notice): If the capstan shaft is covered with oil, wipe it off thoroughly.

2. Remove the pinch roller and exchange it for one of larger diameter.

(Notice): Care must be taken not to smear the surface of the rubber roller with oil or dirt from the hands. Dirt and stains may be removed with carbon tetrachloride, absorbed in a piece of cloth.

3. Change the equalization of the amplifier to "SLOW". ("FAST" is 7-1/2 ips speed.)

Loading the Tape

Loading the tape for either playback or recording is performed in the same manner. (See Fig. 1)

1. A full reel of tape is mounted on the left hand shaft, and an empty reel is placed on the right.

(Notice): Both reels must be the same diameter.

2. The Function Switch must be set in either "FAST FWD" or "REWIND".
3. Thread the tape as shown in Fig. 1.
4. Insert the end of the tape in the slot of the take-up reel (right side), and turn the reel a few times counterclockwise.

5. When the tape recorder is used in the vertical position, reel clamps must be used on both reels.

Power Source

Turn on the power switches at the tape deck and the amplifier.

Operation of the Tape Transport

Operation of the tape transport is controlled by the "Function" lever and the "Start", "Stop" push-buttons.

Playback

Put the Function Switch in the "Play" position and push the Start Button.

Stop

The tape may be stopped at any time by depressing the Stop Button.

Fast Winding

1. Put the Function Switch in the "FAST FWD" position.
2. Push the Start Button.
3. "FAST FWD" or "REWIND" operation may be done at any time without first pressing the "Stop Button".

On the other hand, when "Play" is desired during "FAST FWD" or "REWIND", the tape must be stopped by pushing the "Stop Button" before changing the "Function Switch".

Rewinding

1. Put the "Function Switch" in the "REWIND" position.
2. Push the "Start Button".

Playback

1. Change the meter switch to "OUTPUT".

2. Change the "PLAY SELECT" switch on the deck panel to 2T (2 track) or 4T (4 track).
3. Set the "EQUALIZATION SELECTOR" switch to the proper tape speed.
4. Set the "FUNCTION SWITCH" in the "PLAY" position and press the "START" button.
5. Volume is controlled by turning the "OUTPUT" knob toward the "TE AC" side. Make sure that the hand of the meter stays within a moderate range.
6. Caution: Do not push the "RECORD" button. Your valuable tape will be damaged.

Recording

1. Adjust the "METER" switch on the amplifier to the "RECORD" position.
2. Depending upon your recording requirements, the "PLAY SELECT" switch on the deck should be set to "STEREO", "CHAN. 1" or "CHAN. 2".
3. The record level may be adjusted by the "MIC" or "LINE" controls. Make sure that the hand of the meter stays within the normal range.
4. The tape is started with the "FUNCTION SWITCH" in the "PLAY" position and will be ready to record when the "RECORD" button is pushed (the pilot lamp next to it will light).
5. Monitoring of record input or playback output can be performed by turning the "OUTPUT" knob toward "SOURCE" or "TAPE" respectively.
6. The level of playback output can be obtained by putting the meter switch in the "OUT" position.
7. Movement of the tape is stopped by pushing the "STOP" button on the tape deck and the recording circuit is disconnected simultaneously.

M A I N T E N A N C E

Cleaning:

For optimum results the machine must be kept clean and dry at all times. It is also suggested that the following parts be wiped off with a piece of soft cloth before putting the machine in operation. Occasionally these parts should be wiped off with a piece of cloth soaked with pure alcohol or carbon tetrachloride.

- a. The surface of each head.
- b. The capstan.
- c. The surface of the pinch roller (rubber)
- d. The tape guides and arms.
- e. The impedance roller.
- f. The head guide.

Please be careful not to stain or smear the rubber part of the pinch roller with oil from the hands. Wipe with carbon tetrachloride when dirty.

Demagnetization:

Head:

Head magnetization, which is often caused by amplifier malfunction, mistreatment of the machine, or contact with magnetized items, results in poor frequency characteristics or an increase in noise level. The heads are also easily magnetized when unbalanced pulses pass through the recording head. This sort of pulse comes from the signal circuit or the power circuit. The following will help you prevent the above:

1. While recording, do not touch the vacuum tubes in the amplifier.
2. While recording, do not connect or disconnect head lead or the interconnecting cables.
3. Do not push the "RECORD" button before the "START" button. A delay of 1/2 sec. will be adequate.

4. Do not make continuity or ohmmeter checks of the heads. That is, do not allow DC to pass through the heads if the heads are magnetized, demagnetize them with a demagnetizer.

Demagnetizing method: Place one end of the demagnetizer as close to the head surface as possible (but do not touch), and move it up and down a few times, slowly. When not effective, repeat several times.

Other Parts:

No magnetic material is used except for the heads. Please demagnetize scissors etc. which are used for tape editing.

Oiling:

The following places need to be oiled with a spindle oil of fine quality (oil for a sewing machine is satisfactory).

1. Motor : Remove lubrication caps in the deck panel and drop panel and drop oil into them. Frequency of oiling depends upon conditions, but should not exceed 5 drops once a month, presuming that the machine is used approximately 2 hours a day.
2. Capstan : Oil needs to be applied between the capstan and the dustcap. Five drops every half a year will be sufficient. Care must be taken not to smear the capstan with oil.
3. Pinch Roller: Remove the pinch roller cap (it will come off when turned counter-clockwise. Three drops on the shaft every three months will be sufficient. Care must be taken not to smear the rubber surface. Clean it with carbon tetrachloride, when smeared. Oil must not be applied to places other than the above. Care should be taken not to over-oil, as this may cause wow, etc.

A D J U S T M E N T

Since each part of the machine is carefully adjusted at the factory before shipping, there is no need for adjustment except for maintenance or in the event of damage.

Adjustment of Brakes:

The brake tension is adjusted by a double tension adjusting nut. After adjusting the inner nut, tighten the outer nut. The takeup brake operates clockwise and the supply brake operates counter-clockwise. Maximum braking action is 14 inch-ounce.

Adjustment of Pinch Roller Pressure:

The pressure of the pinch roller against the capstan is approx. 4.5 lbs. Adjustment is made in an operating condition by a pressure regulating screw on the capstan solenoid. This is a double nut, similar to that used on the brakes. In adjusting the pressure, do not screw the nut too tight, since this may prevent proper seating of the solenoid plunger. Operate a few times to assure proper adjustment.

Hold Back Tension:

Back tension is determined by a fixed resistance (R4) inserted in series with the motor. Consequently, the resistance value can not be adjusted but may be changed when used at another power frequency. The normal tension is approx. 3 inch-ounce.

Takeup Tension:

Takeup tension is fixed as in the case of back tension. The normal tension is approximately 4 inch-ounce.

Adjustment of the Playback Circuit:

The adjustment of the playback circuit is made as follows:

1. The azimuth adjusting signal (7,500 c/s) of a standard frequency tape (NARTB standard 7.5 ips) is reproduced, and while so doing, the azimuth adjusting screw on the playback head is adjusted for maximum output.

(Observe and check the upper and lower channels simultaneously or in turn.)

2. The level adjusting signal (250 c/s) is reproduced, and the "PLAYBACK" level is adjusted so that a level meter (V T V M) connected to the output terminals will read +4 dB at which time the meter on the amplifier indicates a point 2/3 of the total scale or 0 VU. (An Output level of +4 dB is approx. 1 V will be over the limit.)
3. The frequency response adjusting signal is reproduced, and the "PLAY COMP" in the amplifier is adjusted to obtain the most constant output. The sensitivity of the level meter must be increased since the test signals are recorded at -10 dB.

* In the case of 3 3/4 ips., no equalization adjustment is available

* Adjustment is made on each channel.

Adjustment of the Recording Circuit:

1. Thread a new tape on the machine (Scotch 111A Type or one having equal quality).
2. Set the "OUTPUT" control of the amplifier to "TAPE", and the "RECORD" select to "STEREO".
3. An audio-frequency oscillator is connected to the "LINE" "INPUT" and set for 200 c/s. (Input level is -10 dB.) The playback output level is set from -5 to 0 dB by adjusting the "RECORD LINE" level.
4. When the bias adjust in the back of the amplifier is turned clockwise, the playback output increases gradually to a maximum. Continue clockwise rotation until the output drops to a point 1/2 dB.
5. The recording input should be adjusted so that the playback output level of a 200 c/s signal will be 0 VU (between "NORMAL" and "OVER" on the meter).
6. The meter switch should be changed to "RECORD" to assure that the meter indicates at or around "0 VU". A small error may be

compensated for turning the REC. LEVEL CAL adjustment.
If this error is large, the record output circuit or the record head is faulty.

(Notice): A record level of 0 VU is made to be approx. -11 dB below the saturation point.

7. The record input is now reduced so that the playback output level of 200 c/s will be -24 dB.
8. Each frequency is recorded to check the playback output. The adjustment of high end (around 10 kc) is made with a compensating choke (CH1). The adjustment of a frequency around 5 kc is made with C7 (C8 in the case of 3 3/4 ips). 1 or 2 dB error may be compensated through a slight adjustment of "PLAY COMP".
9. Each channel and speed is adjusted in a like manner.

Noise Adjustment in the Playback Circuit:

Adjustment of noise (hum) in the playback circuit is made with "HUM BAL" control on the back of the amplifier, so that the hum level of the playback output will be at minimum.

Power Voltage Alteration:

1. Deck - Taps on resistance R3 at the side of the takeup motor (100V; 100 Ω , 117V; 150 Ω), taps on resistance at the side of the supply motor (100V; 30 Ω , 117V; 50 Ω).
2. Amplifier - The tap lead to the power transformer should be changed (100V; gray lead, 117V; brown lead).

(Refer to the Fig. 8.)

Power Frequency Alteration:

The motor pulley should be exchanged (smaller one is for 60 c/s).

Exchange of Parts:

Your request for maintenance or repair parts should indicate the following.

- 1) Model Number (Ex. TD - 105A)

- 2) Serial Number (Ex. No. 6051)
- 3) Part Number (Ex. TW 15 - 3)
- 4) Description of Part
- 5) Quantity

Faulty parts shall be replaced at a nominal cost.

ACCESSORIES CHART

R - 101, R - 102

Part No.	Name or Composition	Lng.	U s e	Q'ty
WR 101A	US Plug (Mle)-US plug (Fel)	1.5cm	Deck-Amp. (For A channel)	1
WR 101B	" "	"	" (For B channel)	1
WR 102	Pin Plug-Pin Plug	50cm	For Bias synchronization	1
CN 604	Phone Plug		For Microphone or line	2
TR 116	Pinch Roller		For 3 3/4 ips. speed	1
TC 19031	60 c/s motor pulley		50 c/s (TC19030) goes with 60 c/s	1
TZ 113	Reel Clamp			2

R - 103

WR 101A			For Deck-Amplifier	1
CN 604	Phone Plug		For Microphone or Line	1
TP 116	Pinch Roller		For 3 3/4 ips. speed	1
TC 19031	60 c/s motor pulley			1
TZ 113	Reel Clamp			2

Deck only

WR 108	US Plug (Fel) AC Plug	2.5cm	For Deck Power input	1
CN 811	US Plug (Fel)		For B channel deck input	1
TP 116	Pinch Roller		For 3 3/4 ips. speed	1
TC 19031	60 c/s Pulley			1
TZ 113	Reel Clamp			2

VOLTAGE OF ALTERATION

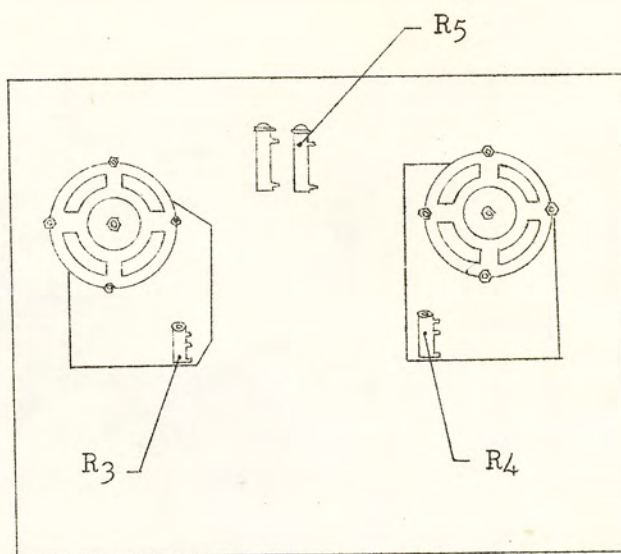

Back View

	100 V	117 V	
R ₃			<p>① Correct ②③ Wrong</p> <p>Head</p>
R ₄			
R ₅			

(Notice): You should adjust R₄ resistor's slide for back tension arm to be in ① position.

Fig. 8

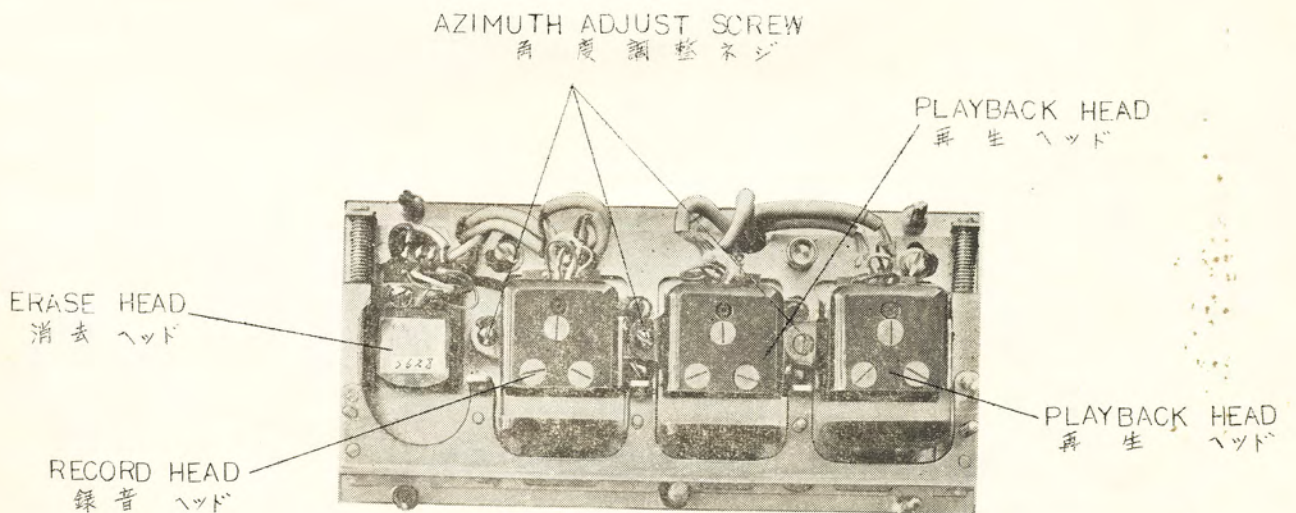
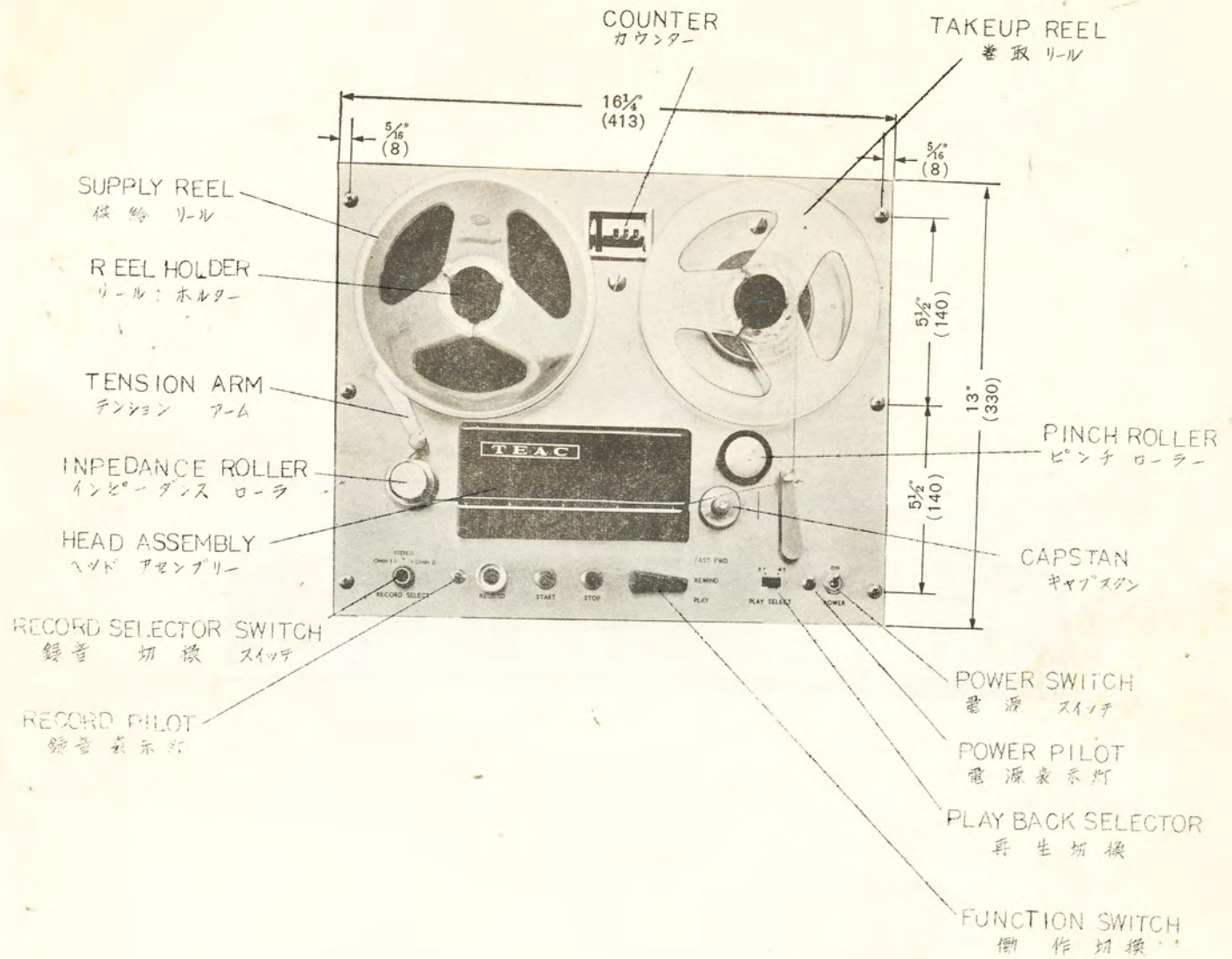

FIG. 1 TAPE DECK FRONTVIEW

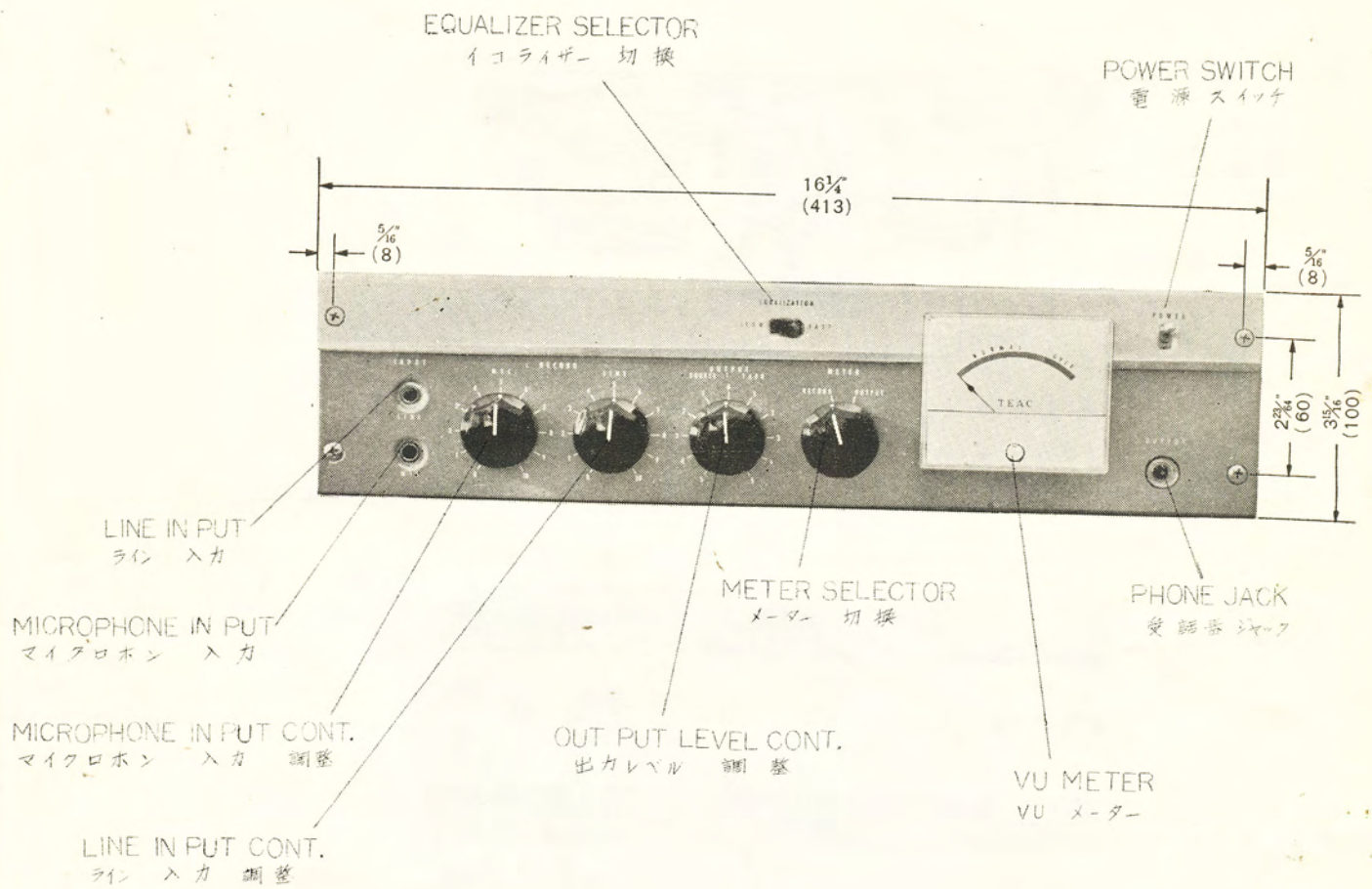
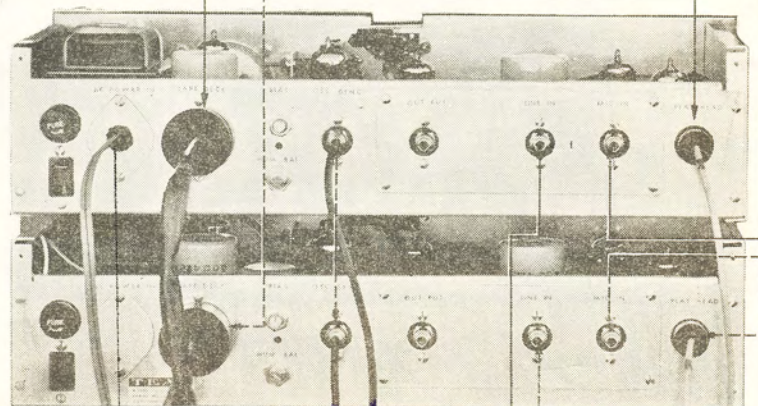
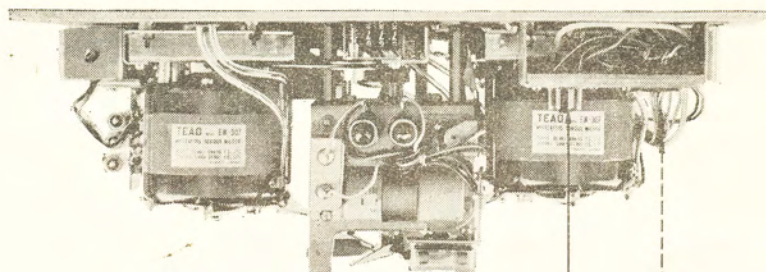

FIG. 2 AMPLIFIER FRONT VIEW

TAPE DECK



RECORD AMPLIFIER CH-A

RECORD AMPLIFIER CH-B

A
B TO MICROPHONE

B
A TO HIGH LEVEL OUTPUT

DR RECORD OUT

A
B TO AUX IN OR TAPE MONITOR

INPUT OR POWER AMP.

TO AC POWER

100 OR 117 VOLT

*OSC SYNC
CABLE
(SHORT CABLE
w/ plug on both
ends)*

FIG. 3 INTER CONNECTING

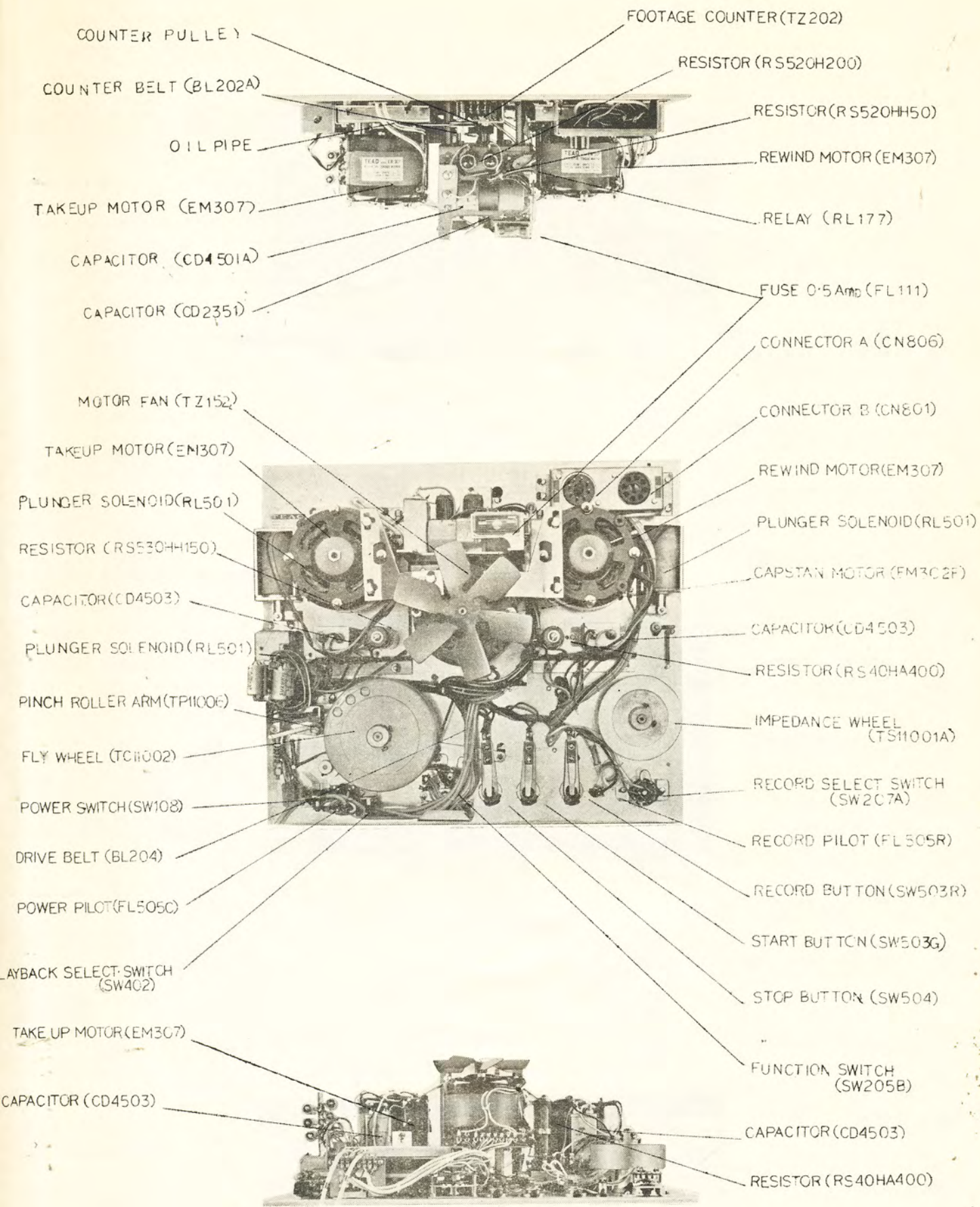

FIG. 4 TAPE DECK BACK VIEW

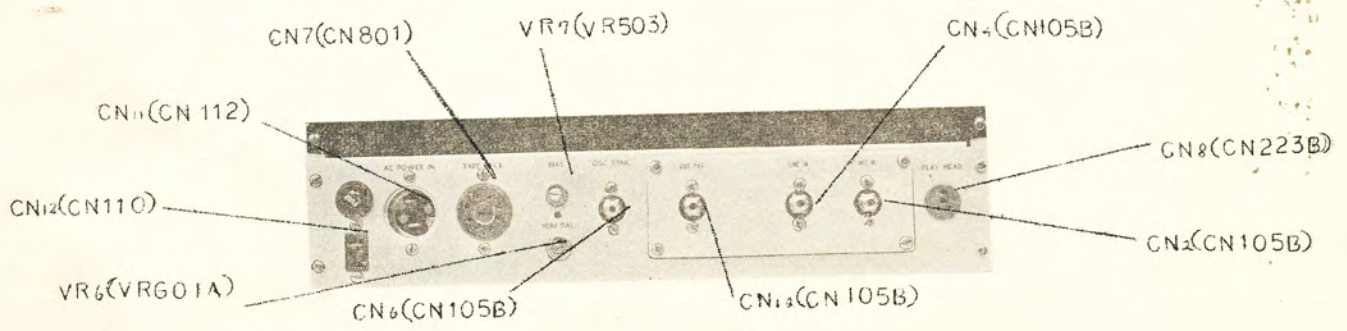
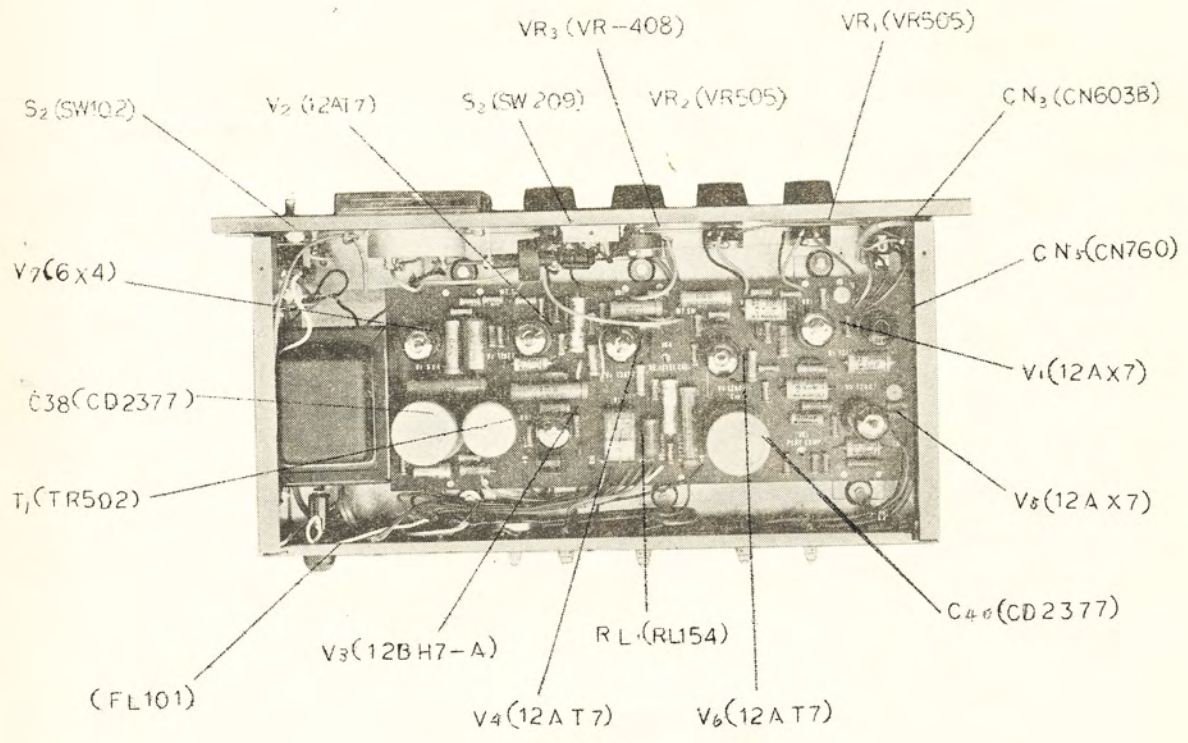
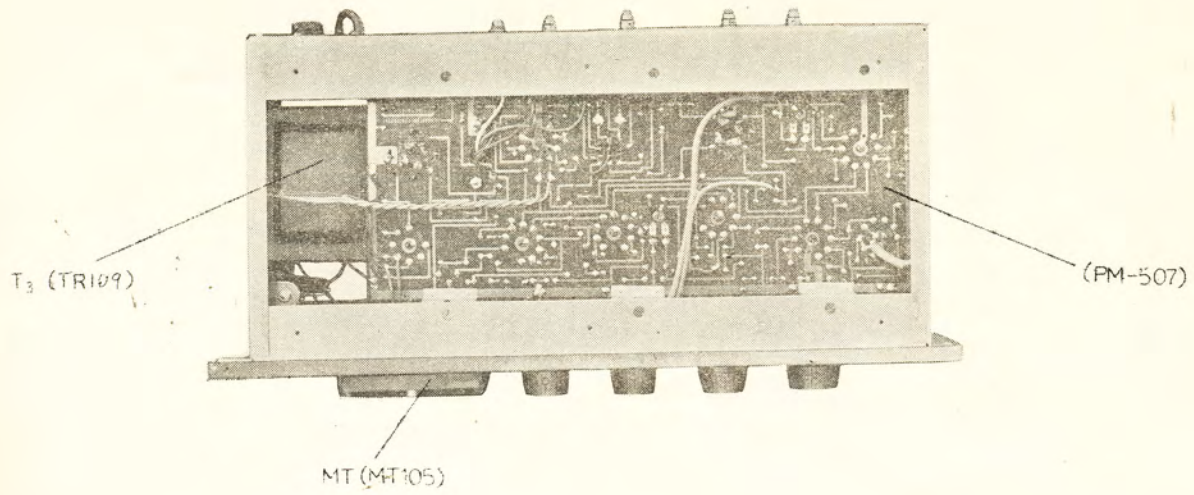
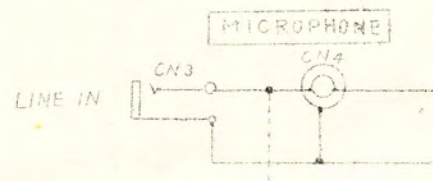
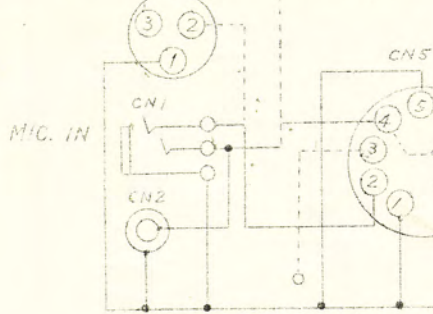
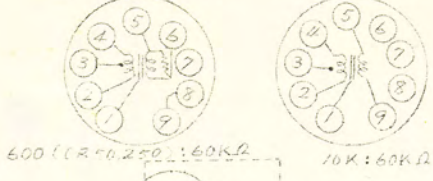
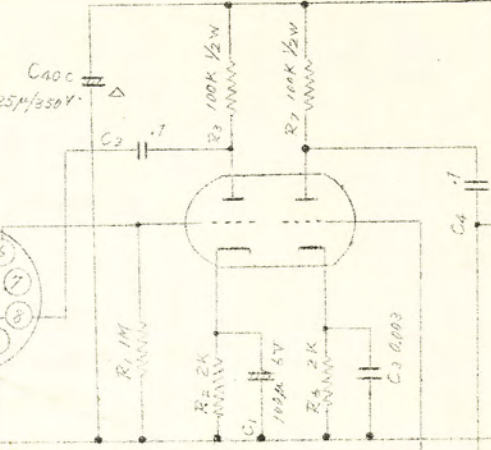

FIG.5 AMPLIFIER BACK VIEW

TRANSFORMER FOR MICROPHONE FOR BRIDGING



V1 ECC 83/12AX7



V2 ECC 81/12AT7

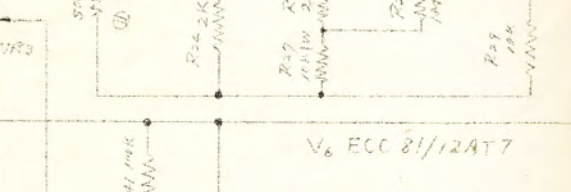
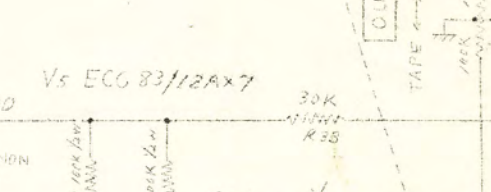
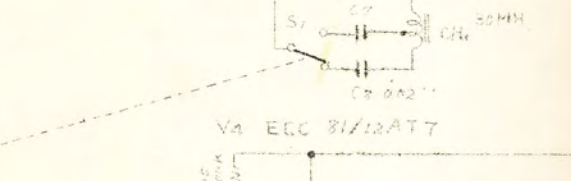
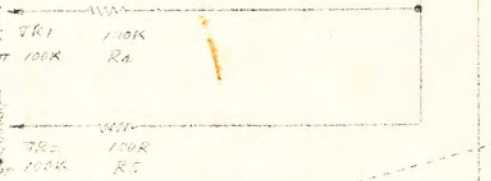
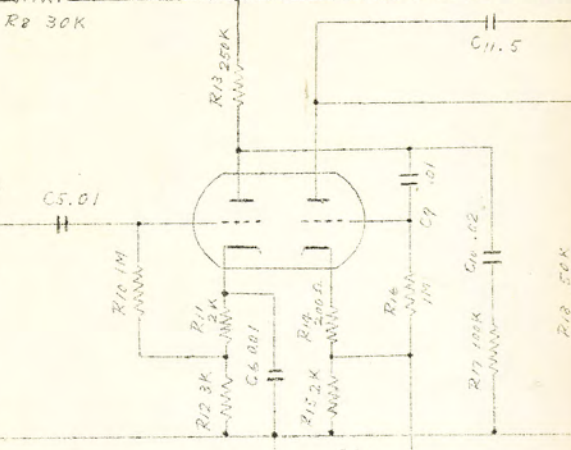

PLAY HEAD

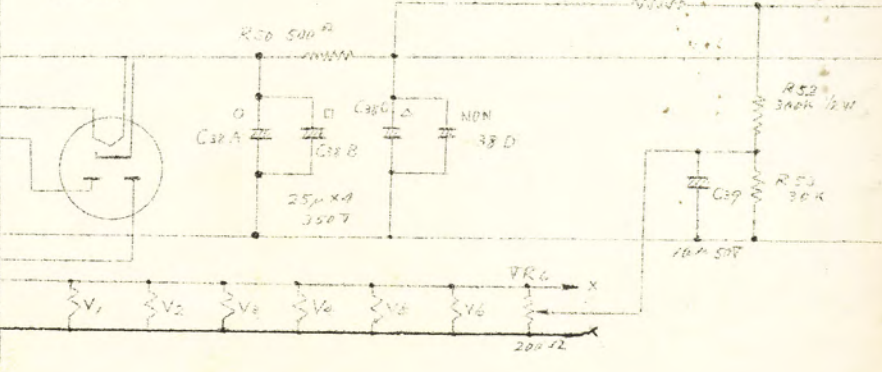
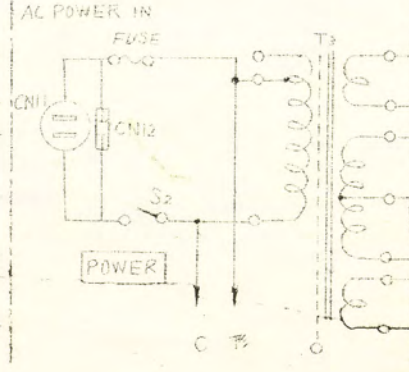
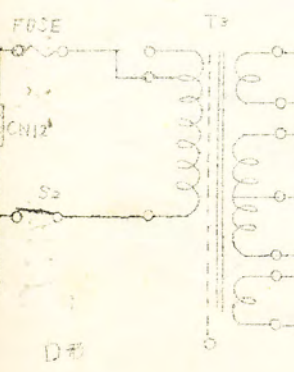
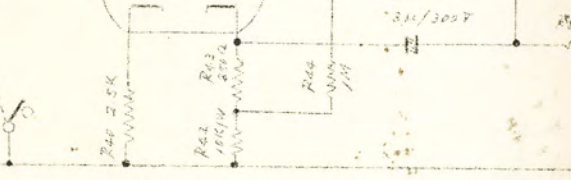
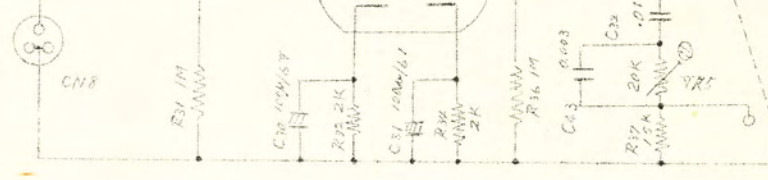

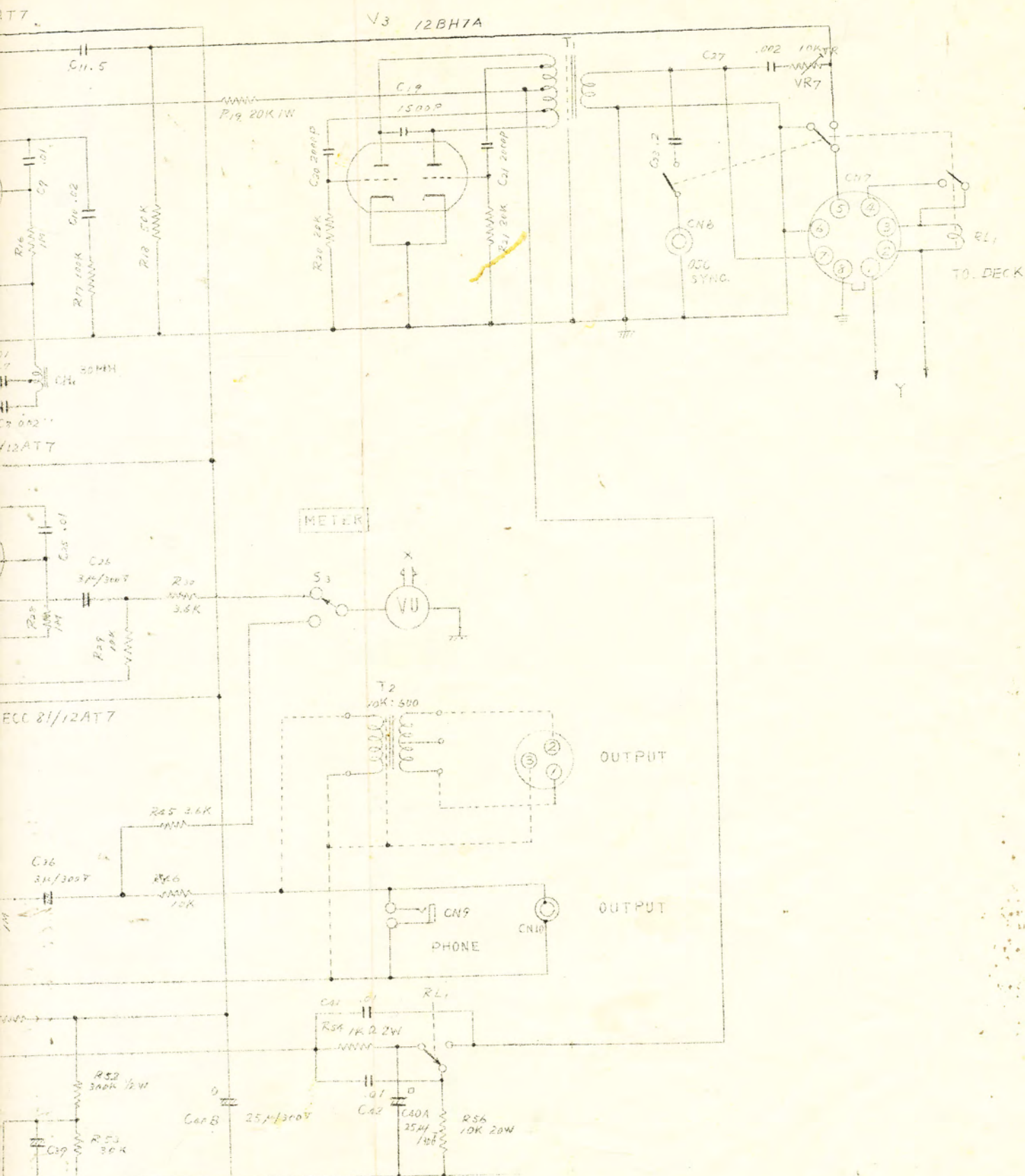

SCHEMATIC DIAGRAM of AR-9

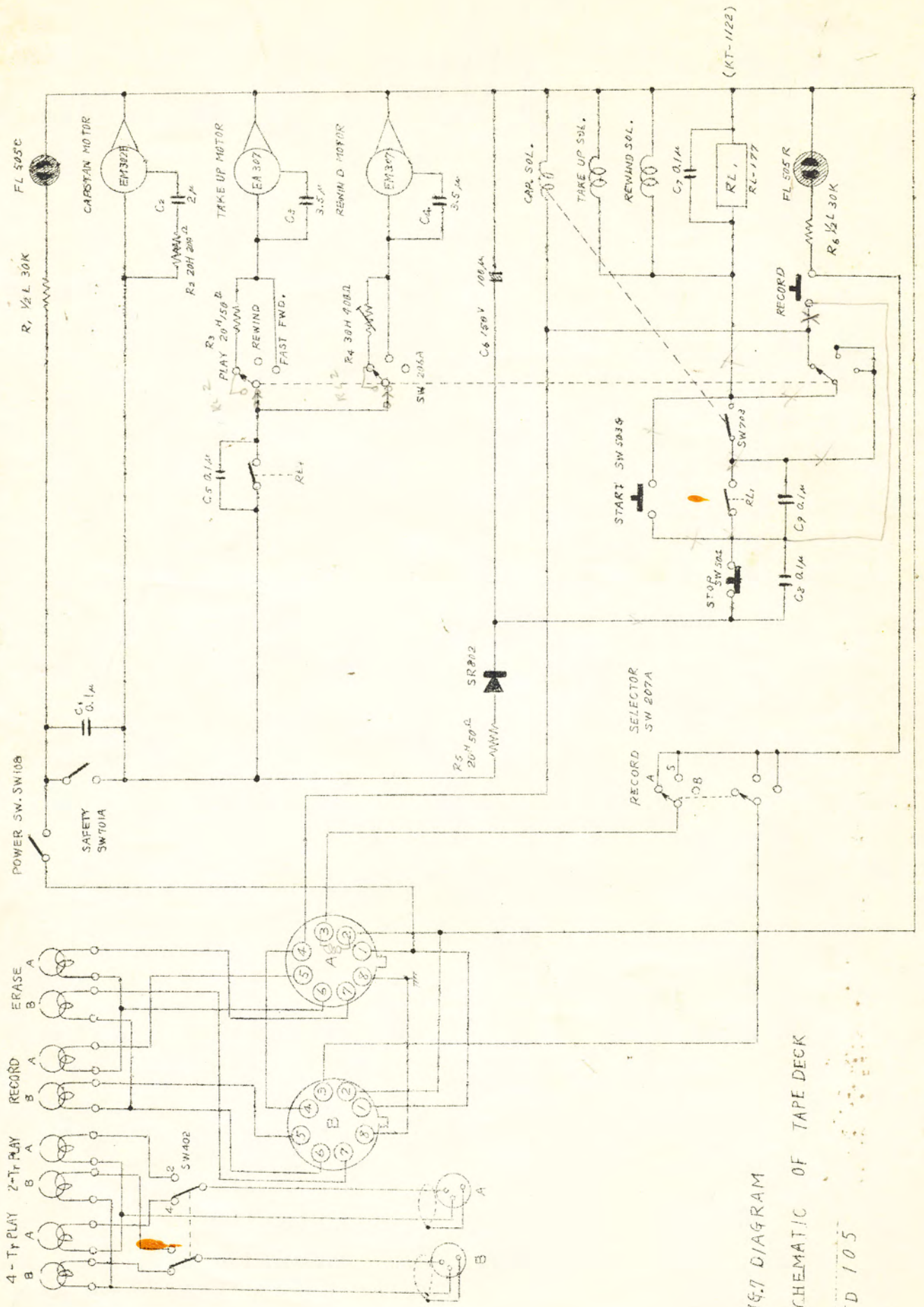

(KT-1122)

FIG.7 DIAGRAM
SCHEMATIC OF TAPE DECK